

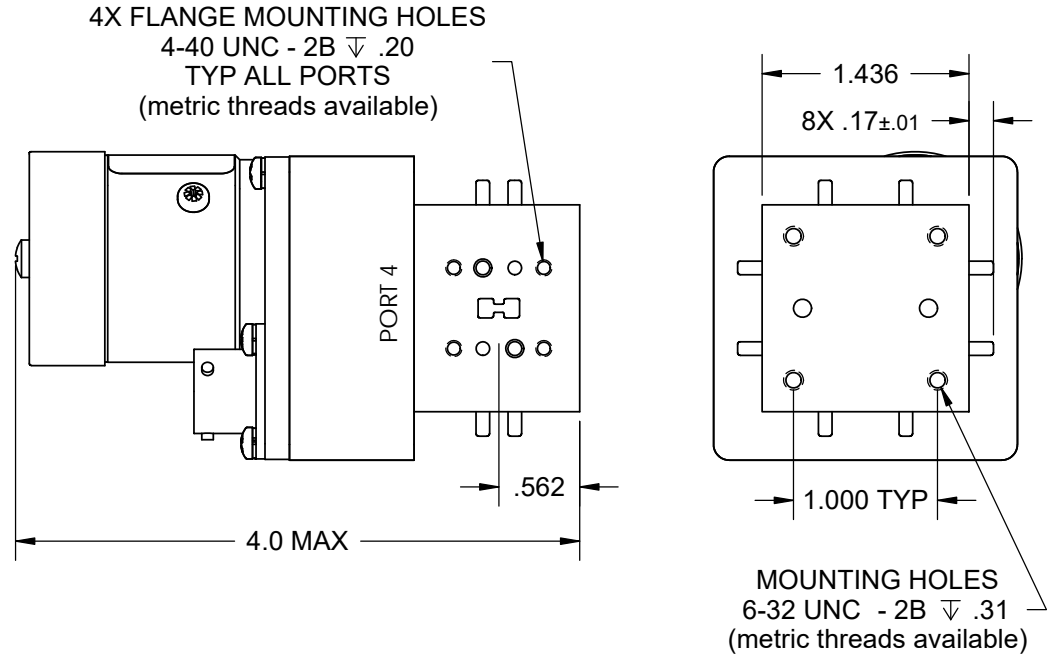

Ridgeguide Switch - LW Series - WRD180

REV. D

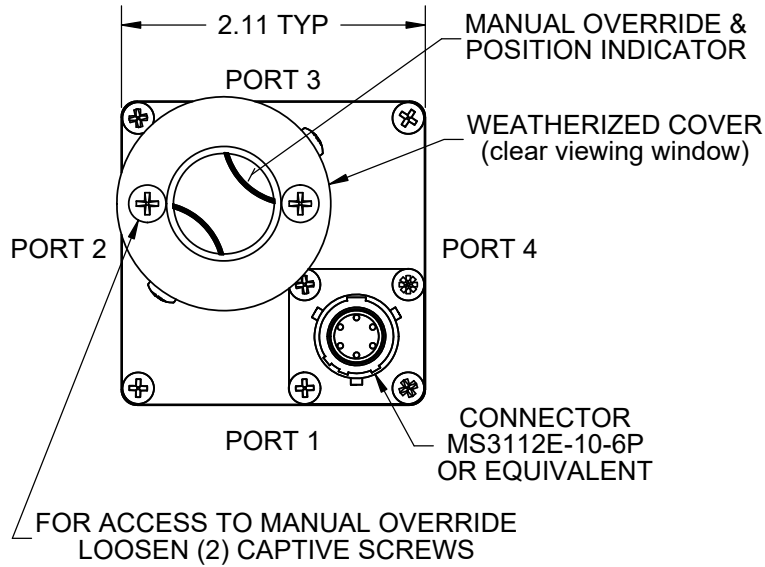

(See Model # Chart to select options)

ELECTRICAL CIRCUIT OPTIONS
NO INDICATORS
1 SET INDICATORS
2 SETS INDICATORS
3 SETS INDICATORS
4 SETS INDICATORS
INHIBIT CIRCUITS

Frequency: 18.0 to 40.0 GHz
 VSWR: 1.30:1 Max.
 Insertion Loss: 0.40 dB Max.
 Isolation: 50 dB Min.

Flange: See Flange Table
 Voltage: See Voltage Table
 Switching Time: 80 mS Max.

Material: Aluminum (RF Assy)
 Finish: Iridite per MIL-DTL-5541
 Paint Dull Black Enamel
 Pressure: 30 PSIG (RF Head Only)
 Drive: Patented Logus I Motor

Temp: Operating: -40°C to +85°C
 Non-Operating: -55°C to +100°C
 Humidity: 0 to 100%, Fully Weatherized

DRIVE OPTIONS
LATCHING
PULSE
LATCHING
FAILSAFE

VOLTAGE OPTIONS
12 VDC
15 VDC
24 VDC
28 VDC
48 VDC
115 VAC

FLANGE OPTIONS
COVER
GROOVE

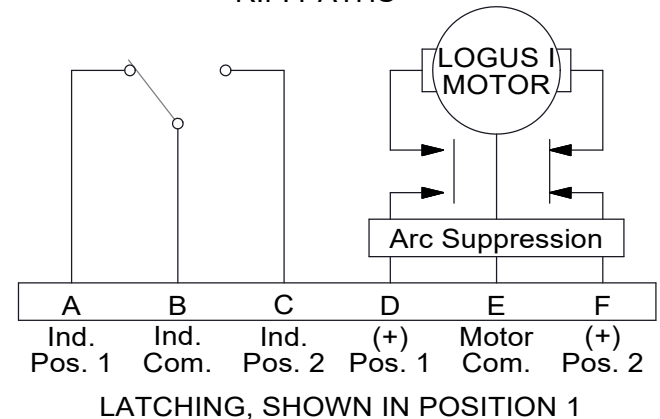
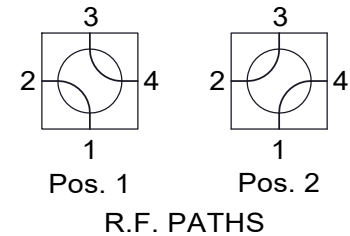

(See Schematic page for optional Electrical Circuits)